

EnveoVent Flex

ARBETSANVISNING



1. Ställning

1. A

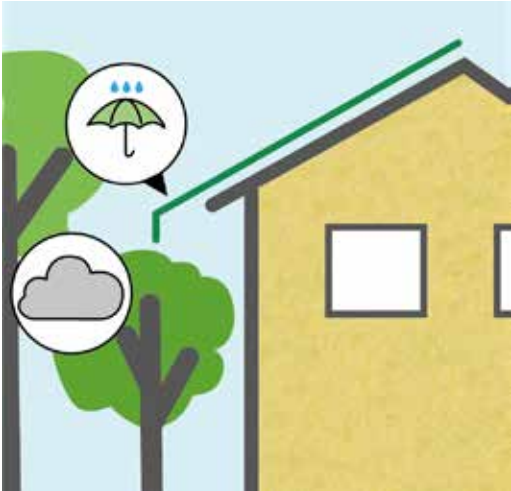

1. B



1. C

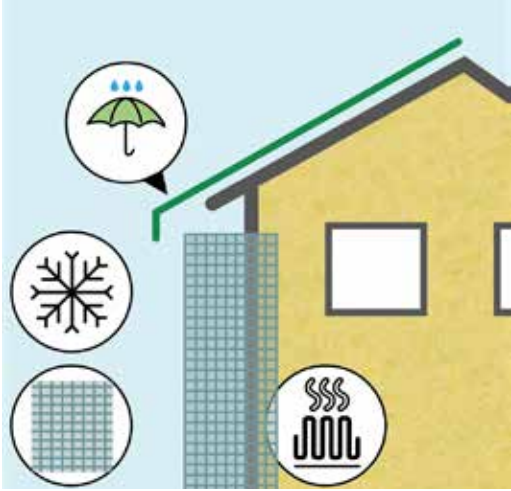

1. D

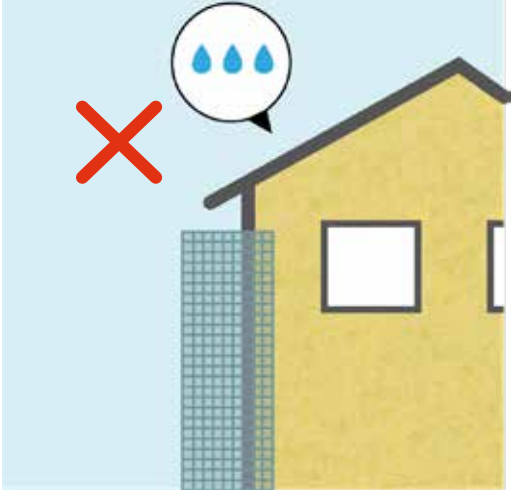

1. E



2. Isolering

webertherm 371 premium 32
weber musprofil

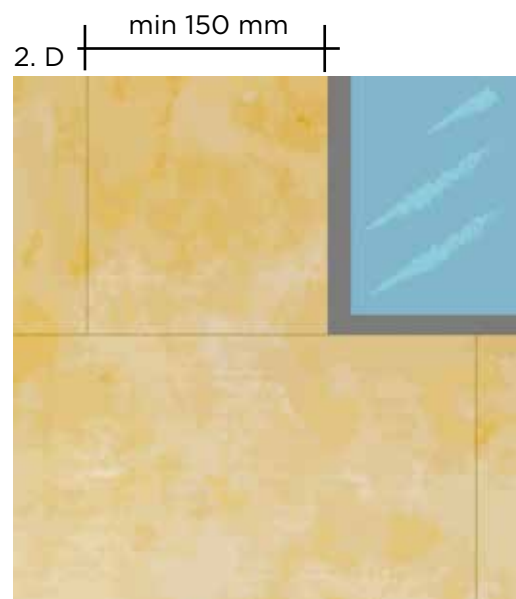
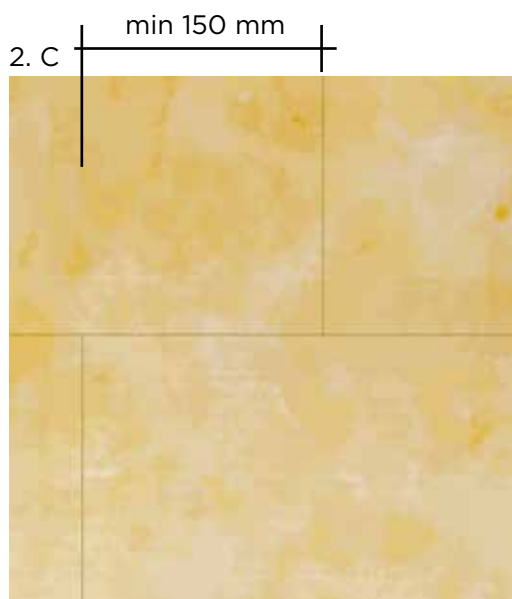
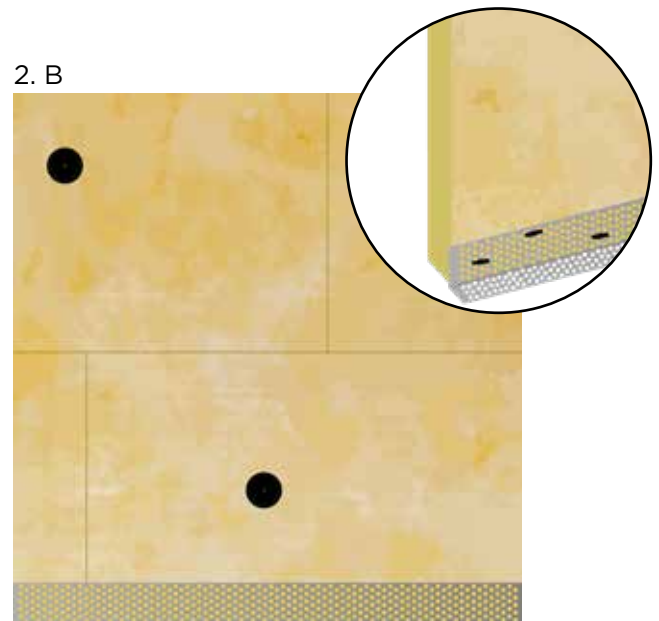
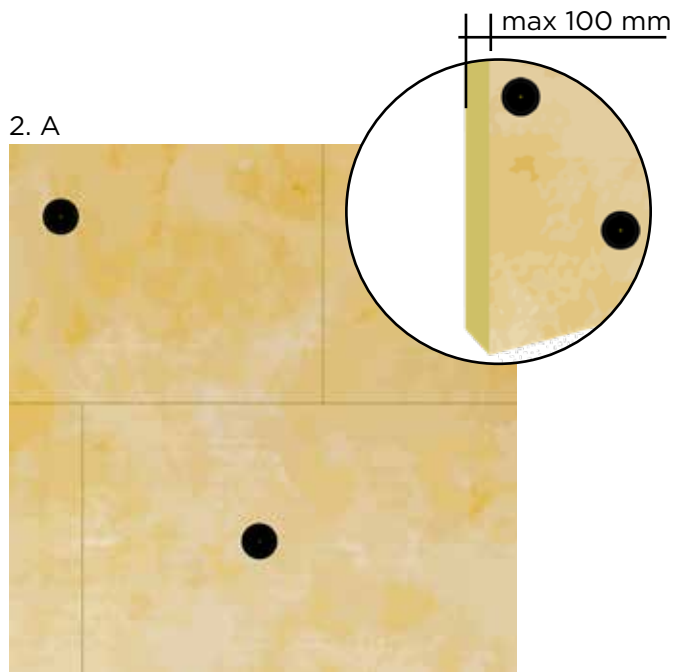

3. Regling

VAP-profil 25 mm alt. träläkt min 28x70 mm

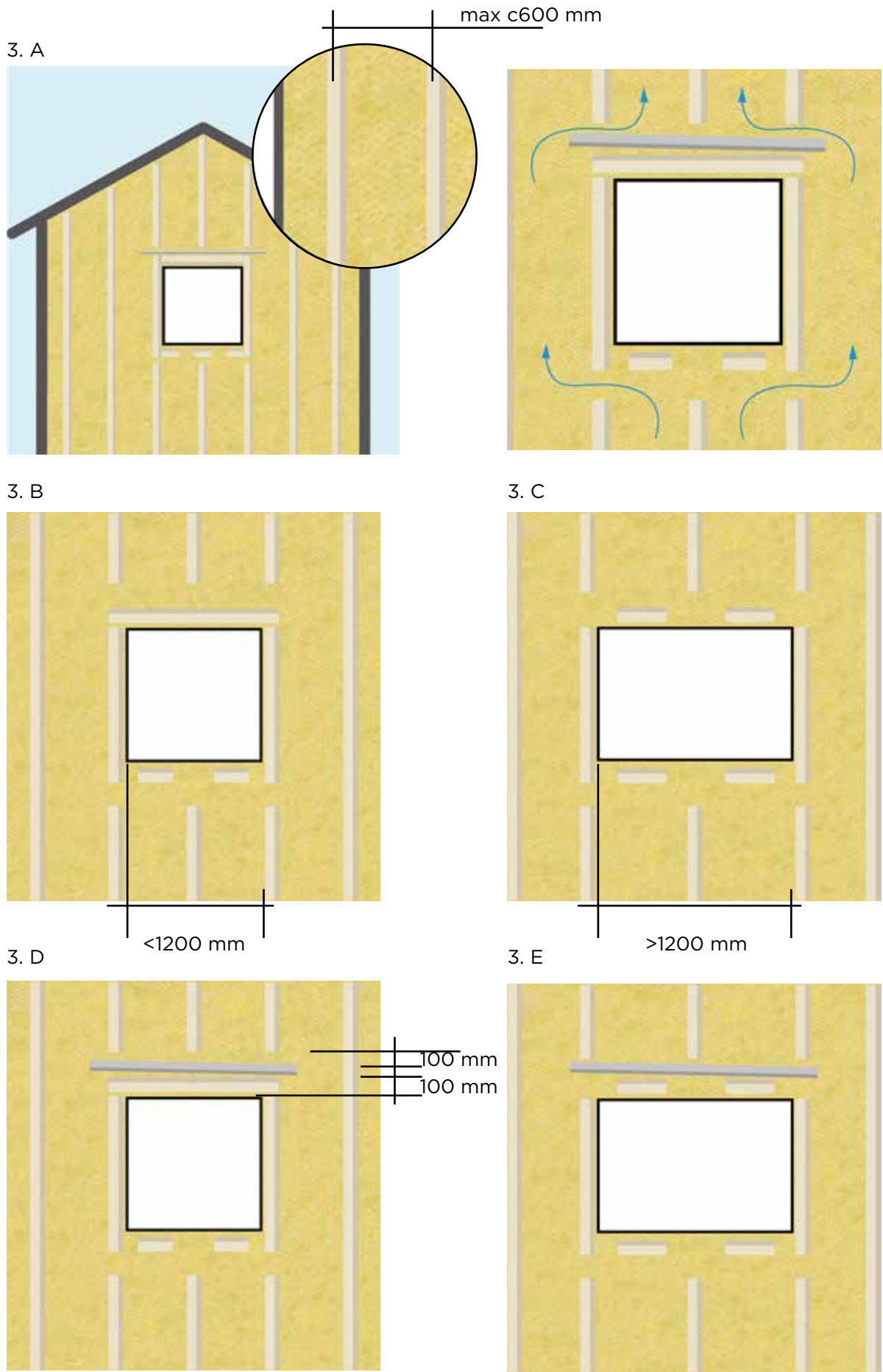

4. Lagring/Hantering

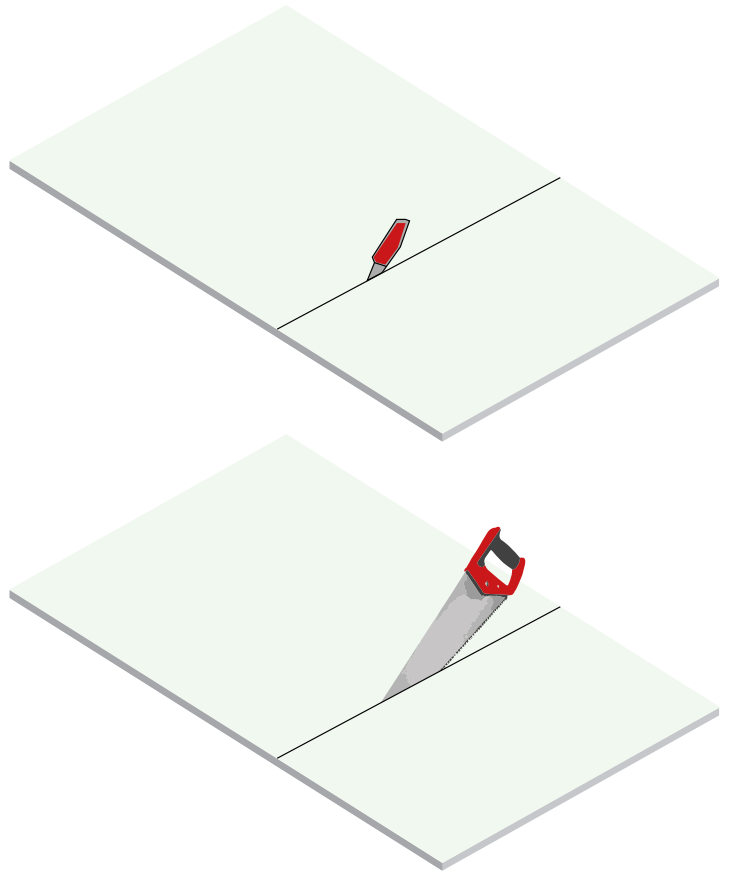
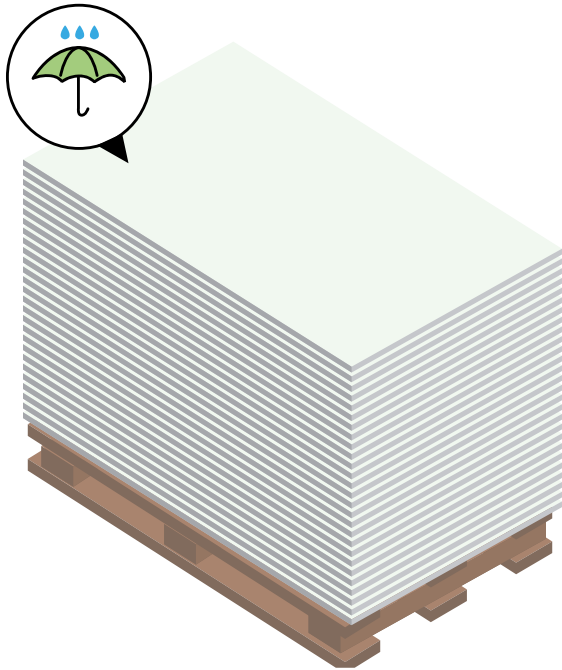

5. Vindlast

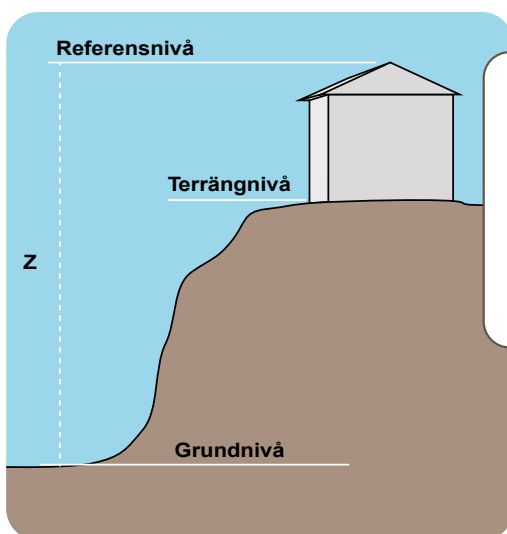

z = >20 m

kontakta:

Weber Tekniksupport

Telefon: 010-211 63 00

E-post: kontakt@weber.se

Chat: [se.weber](https://www.se.weber)

6. Placering

weber WP-skiva
weber EnveoVent startlist

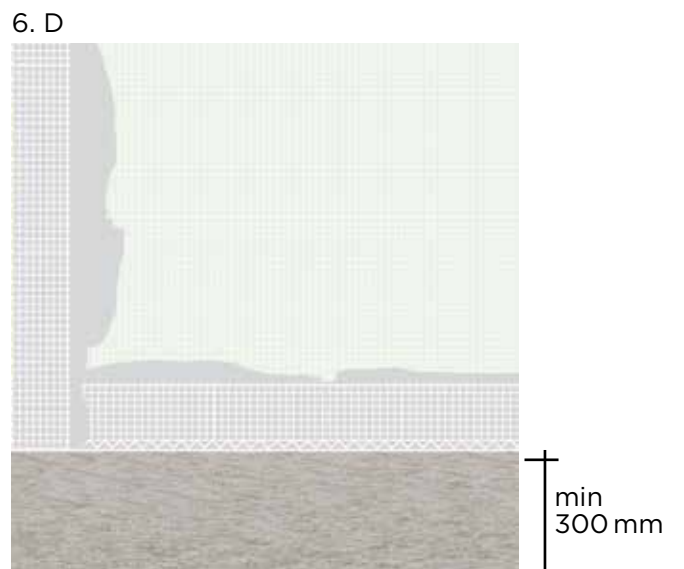
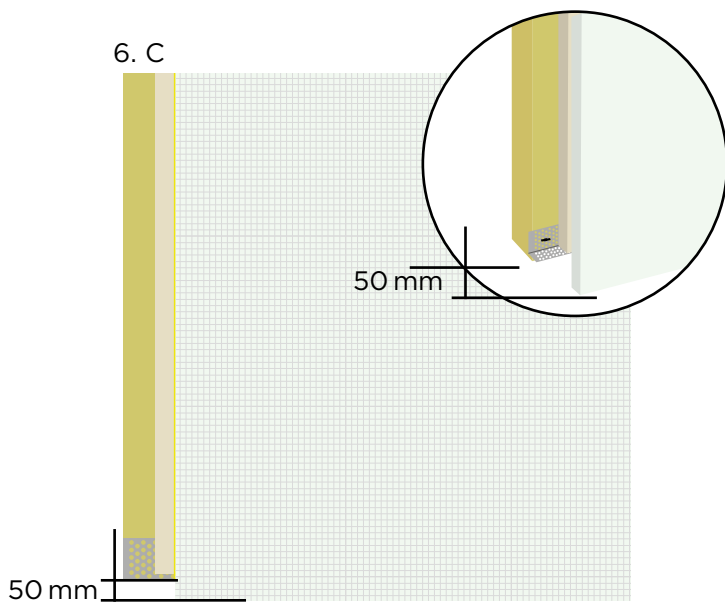
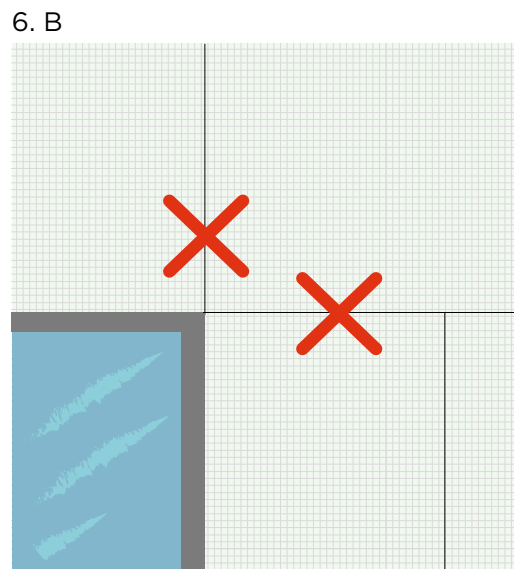
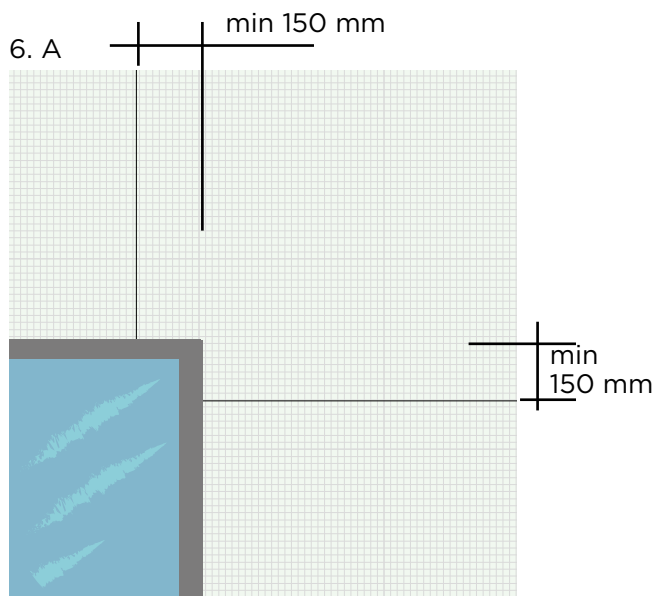
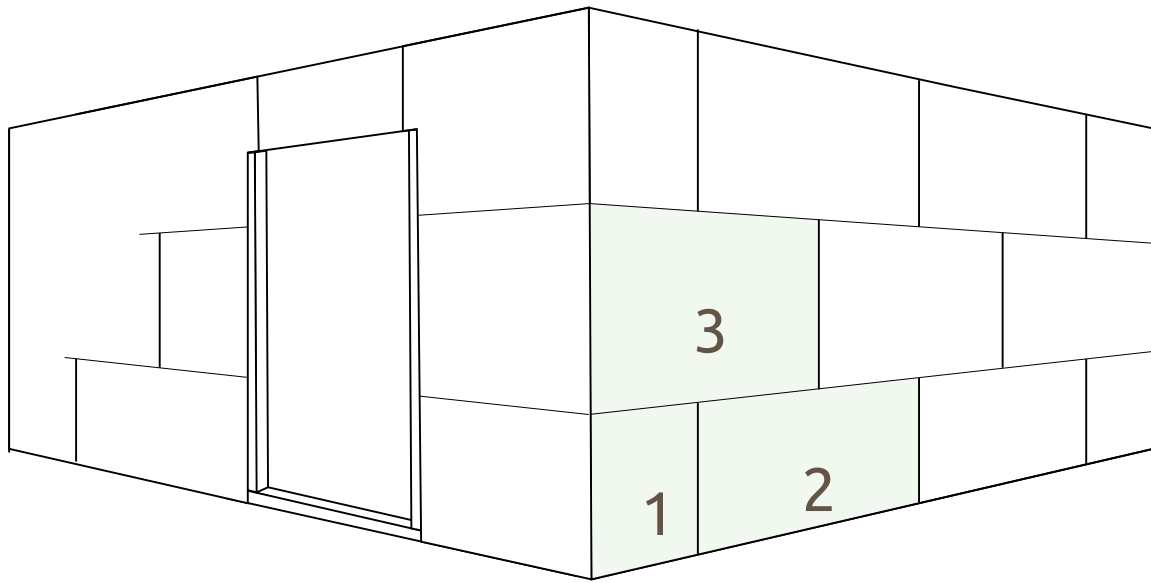

7. Skruvning

weber QU 32 EnveoVent skruv

7. A

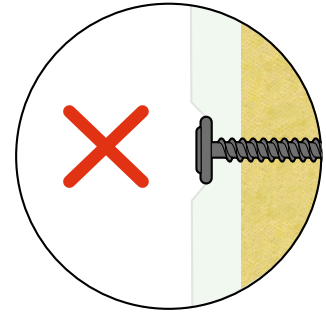
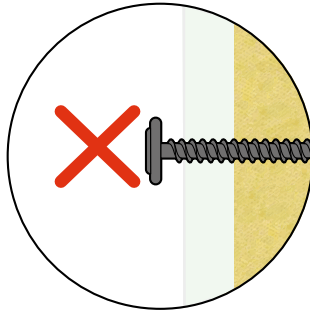
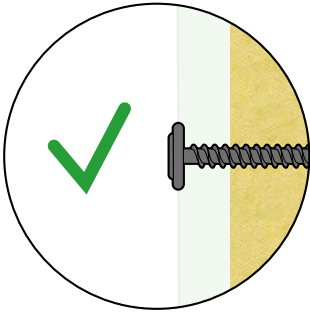

7. B

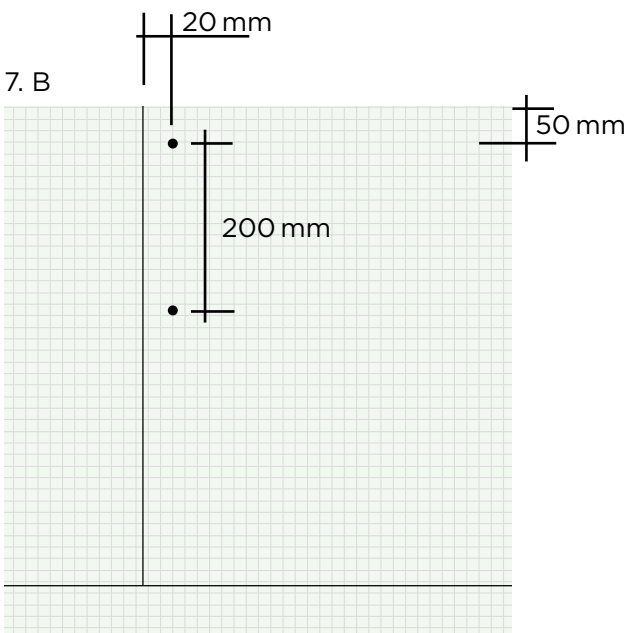

8. List- och hörnförstärkning

webertherm 391 hörnlist

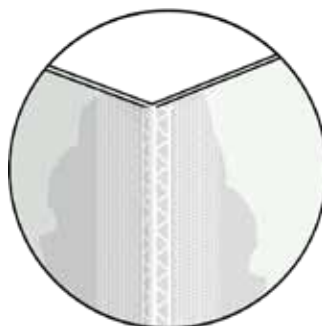
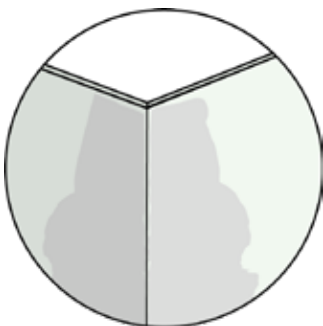

9. Rölsefogar

9. A

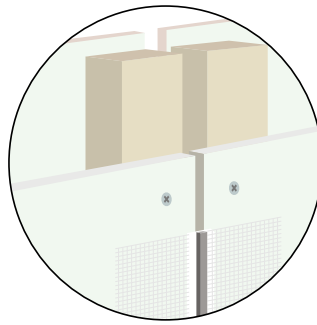
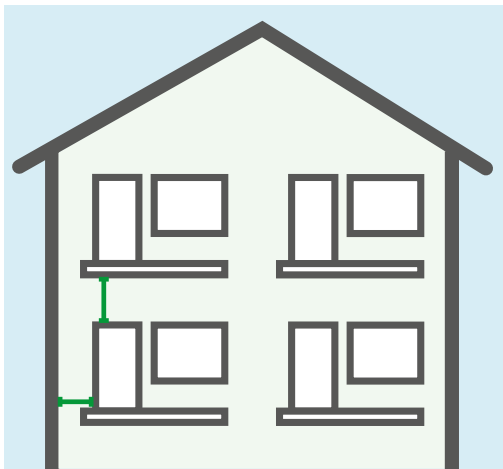

10. Putsning

weber flexiguard
weber 117 armeringsnät

10. A

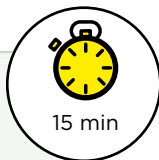

10. B



10. C

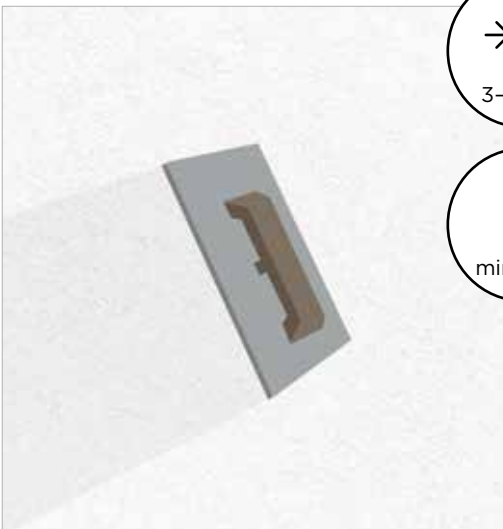

10. D

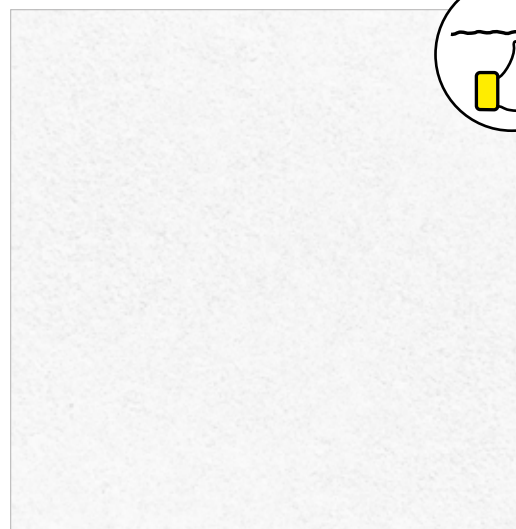

11. Ytputs

weber fasadfärg EF
weber fasadputs EF

11. A

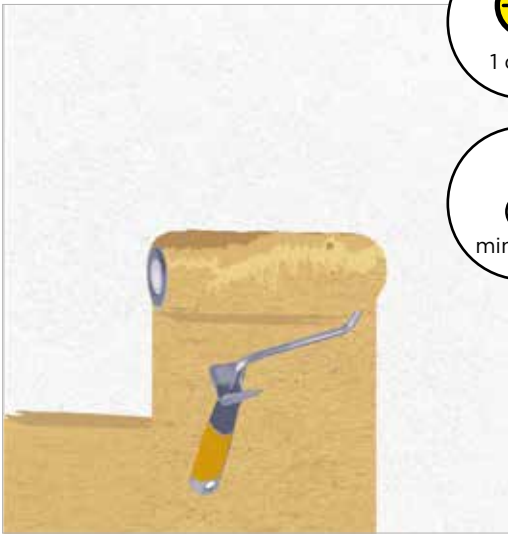

11. B

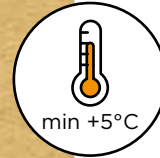
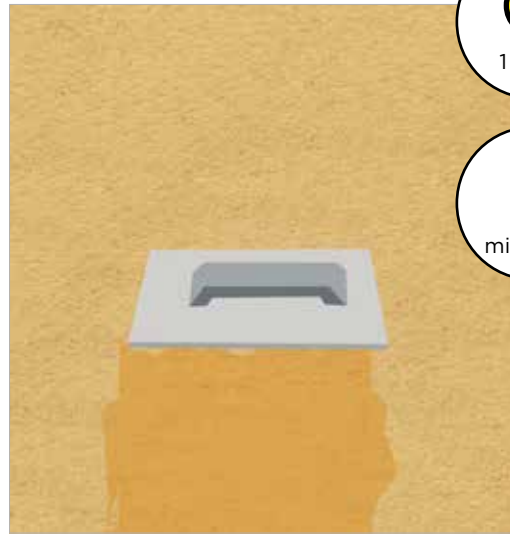

11. C

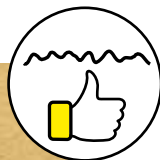
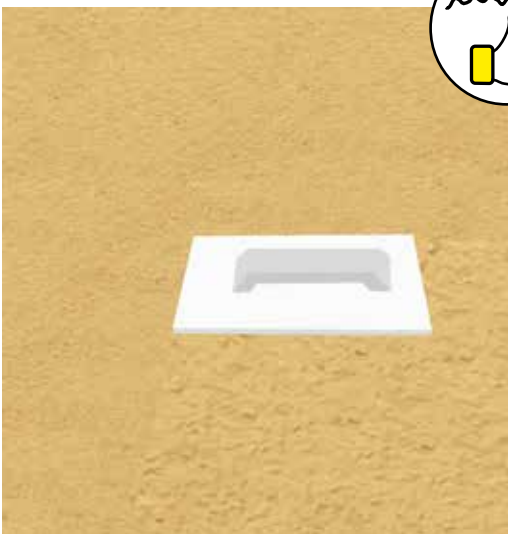

weber WP-skiva

weber flexiguard

weber 117 armeringsnät

weber flexiguard

weber fasadfärg/fasadputs EF



SAINT-GOBAIN SWEDEN AB
WEBER

Box 415, 191 24 Sollentuna
Tel.: (+46) 8 625 61 00
www.weber.se